

DIODE / RESISTOR MODULES

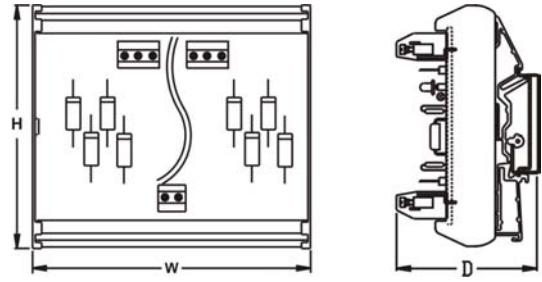

Dimensions

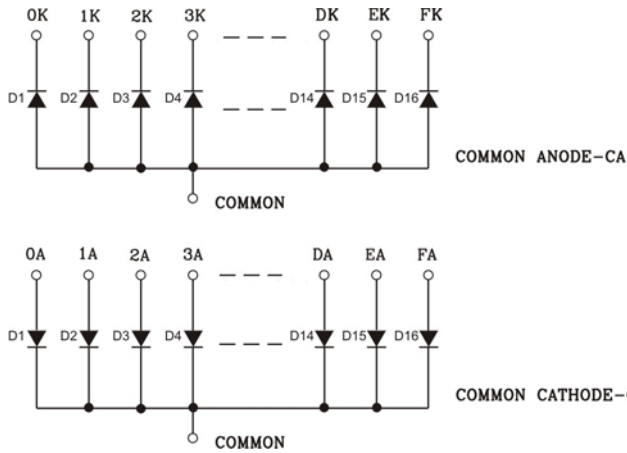

Diode Module Schematic

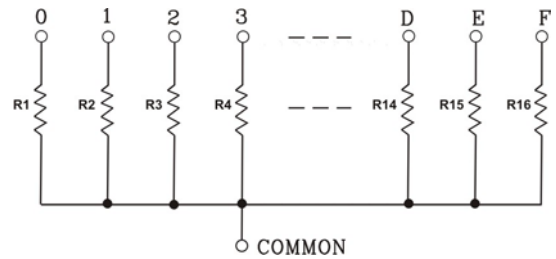

Resistor Module Schematic

NO. OF CHANNELS	2, 4, 8, 16, 32
OPERATING AMBIENT	0~55°C, 85% RH
STORAGE AMBIENT	-20°C to 85°C
TERMINATIONS	Screw type, for 2.5mm sq. wire
MOUNTING	35 mm DIN rail

DIODE MODULES ORDERING INFORMATION	AS601,-CA,-1A				
	NO. OF Diodes	DESIGN NO.	COMMON ANODE / CATHODE	CURRENT RATING	DIMENSIONS W x H x D (mm)
	2	AS601	CA : Common Anode CK : Common Cathode	1A : 1 Ampere 3A : 3 Ampere	24 x 80 x 50
	4	AS602			48 x 80 x 50
	8	AS603			48 x 80 x 50
	16	AS604			92 x 80 x 50
32	AS605	182 x 80 x 50			

MODULES WITH RESISTORS ORDERING INFORMATION	AS601,-101			
	NO. OF Resistors	DESIGN NO.	RESISTOR VALUE & WATTAGE	DIMENSIONS W x H x D (mm)
	2	AS601	101 : all resistors 500E QW For other values Refer Factory	24 x 80 x 50
	4	AS602		48 x 80 x 50
	8	AS603		48 x 80 x 50
	16	AS604		92 x 80 x 50
32	AS605	182 x 80 x 50		

DIODE ORING / RESISTOR MODULES

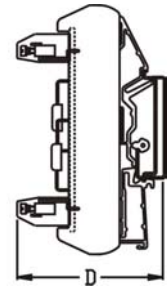
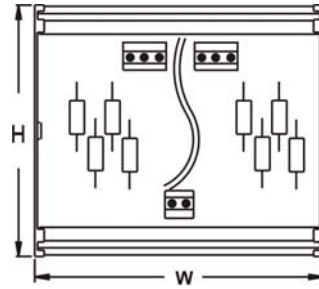

Dimensions

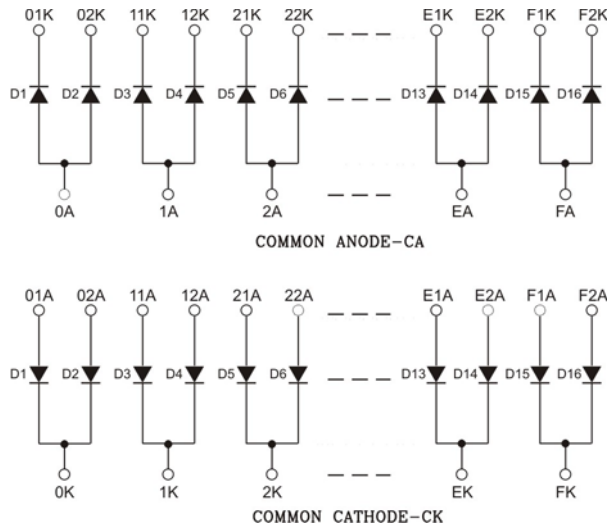

Diode Module Schematic

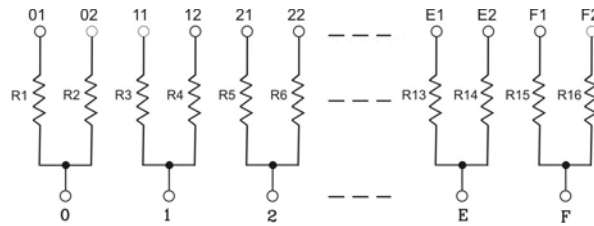

Resistor Module Schematic

NO. OF CHANNELS	1, 2, 4, 8, 16
OPERATING AMBIENT	0~55°C, 85% RH
STORAGE AMBIENT	-20°C to 85°C
TERMINATIONS	Screw type, for 2.5mm sq. wire
MOUNTING	35 mm DIN rail

DIODE MODULES ORDERING INFORMATION	AS606, -CA, -1A					
	NO. OF Channels	DESIGN NO.	COMMON ANODE / CATHODE	CURRENT RATING	DIMENSIONS W x H x D (mm)	WEIGHT (MAX)
	1	AS606	CA : Common Anode CK : Common Cathode	1A : 1 Ampere 3A : 3 Ampere	24 x 80 x 50	-
	2	AS607			48 x 80 x 50	-
	4	AS608			48 x 80 x 50	-
	8	AS609			92 x 80 x 50	130 grams
16	AS610	182 x 80 x 50			-	

MODULES WITH RESISTORS ORDERING INFORMATION	AS606, -101				
	NO. OF Channels	DESIGN NO.	RESISTOR VALUE & WATTAGE	DIMENSIONS W x H x D (mm)	WEIGHT (MAX)
	1	AS606	101 : all resistors 500E QW For other values Refer Factory	24 x 80 x 50	-
	2	AS607		48 x 80 x 50	-
	4	AS608		48 x 80 x 50	-
	8	AS609		92 x 80 x 50	130 grams
16	AS610	182 x 80 x 50		-	